

- 4. Battery Compartment
- 5. 1/4" -20 Mounting Thread
- 6. 5/8" -11 Mounting Thread

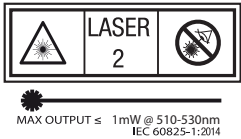
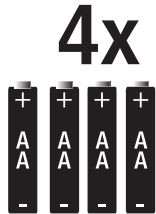

© 2014 STANLEY Tools
701 East Joppa Road
Towson, Maryland 21286
www.STANLEYTOOLS.com

© 2014 The Stanley Black & Decker
Egide Walschaertsstraat 144-16
2800 Mechelen, Belgium
www.stanleylasers.com
70305211 09/2014

STANLEY FATMAX®

FCL-G

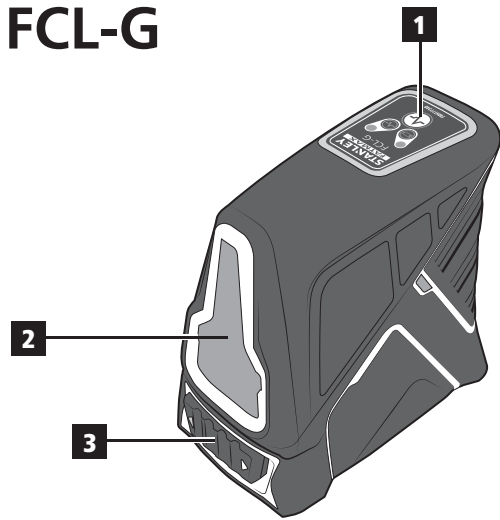

- 1. Keypad
- 2. Laser Window
- 3. Unlock/Lock

EU P/N: FMHT1-77348
US P/N: FMHT77348
70305211

09/2014

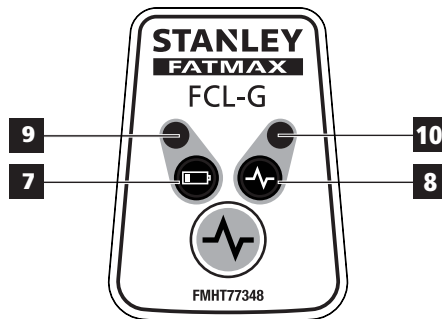
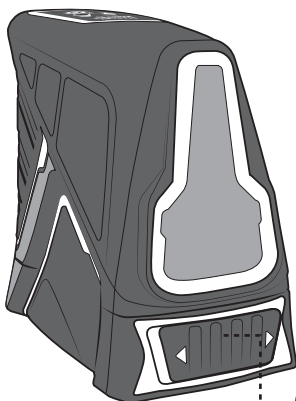
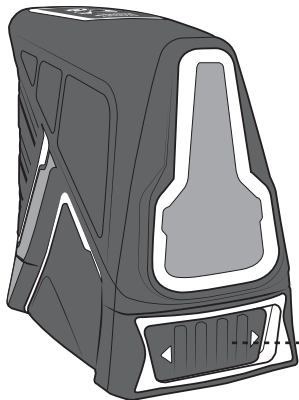

7. Battery Indicator



8. Pulse Mode Indicator



9. Battery Life

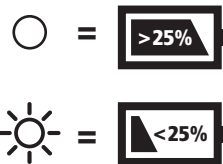

10. Pulse Mode LED

